



Produced from: June 2022

CERAFINE MODEL O

Ideal Standard

BC498AA BC705XX

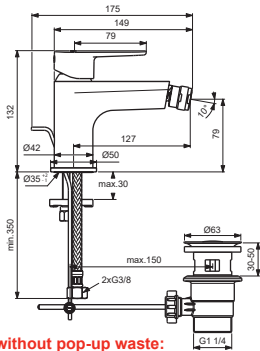

without pop-up waste:
BC554XX
with pop-up waste-plastic:
BC496AA ; BC498XX
with pop-up waste-abs/mess:
BC669XX ; BC705XX
with click waste:
BD131XX

BD716XX

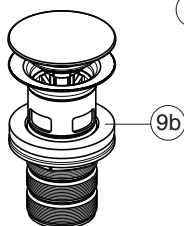
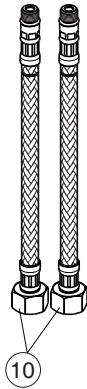
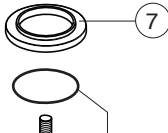
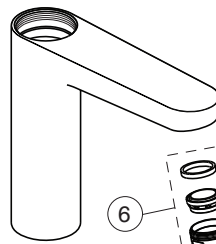
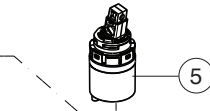
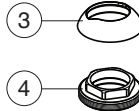
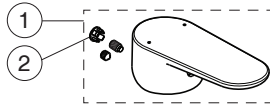
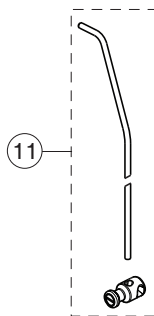
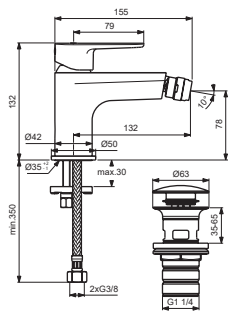

for article:
BC705AA
BD716XX

for article:
BC498AA

for article:
BC496AA
BC554XX
BC699XX
BD131XX

BC496AA BC554XX

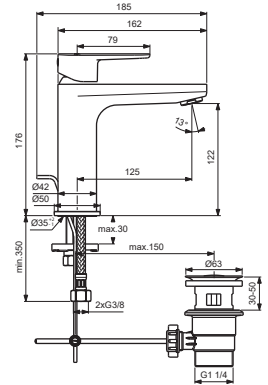

BC699XX

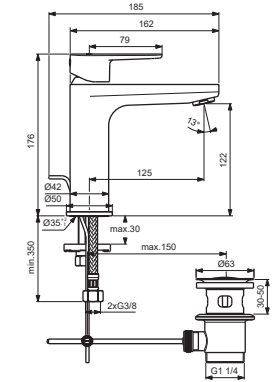

BD131XX

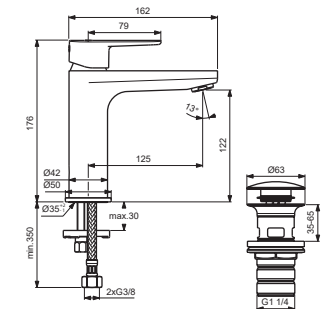

For XX=Coverage-Designate:

AA=chrome,XG=silk black,RO=rosé
Sl=silver,U4=matt black ral 90

For Instance:

B961644AA for chrome

Pos.	Signify	Spare parts-Nr.	Quantity	Pos.	Signify	Spare parts-Nr.	Quantity
1	Lever,w/logo-compl.	B961644XX	1 Set	12	Ball joint M24x1	A960063XX	1 Pcs.
2	Cap decorative	B964696NU	1 Pcs.				
3	Cap	A861080XX	1 Pcs.				
4	Screw M38x1.5	B961645NU	1 Pcs.				
5	Cartridge Ø28mm	A861397NU	1 Pcs.				
6	Perlator M24x1, 5l/min	B961383XX	1 Pcs.				
6a	Aerator M24x1, 5l/min	B960754AA	1 Pcs.				
7	Rosette decorative	B960712XX	1 Pcs.				
8	Connecting set	B964702NU	1 Set				
9	Pop-up waste-plastic	B964550AA	1 Set				
9a	Pop-up drain ass.	A962991XX	1 Set				
9b	Click waste	E1482XX	1 Set				
10	Flex hose F3/8 /L445	A962005NU	1 Pcs.				
11	Pull-up rod-compl.	B960900A5* (AA)	1 Set				

*A5-magnetic grey



Produced from: Nov.2020

CERAFINE MODEL O

Ideal Standard

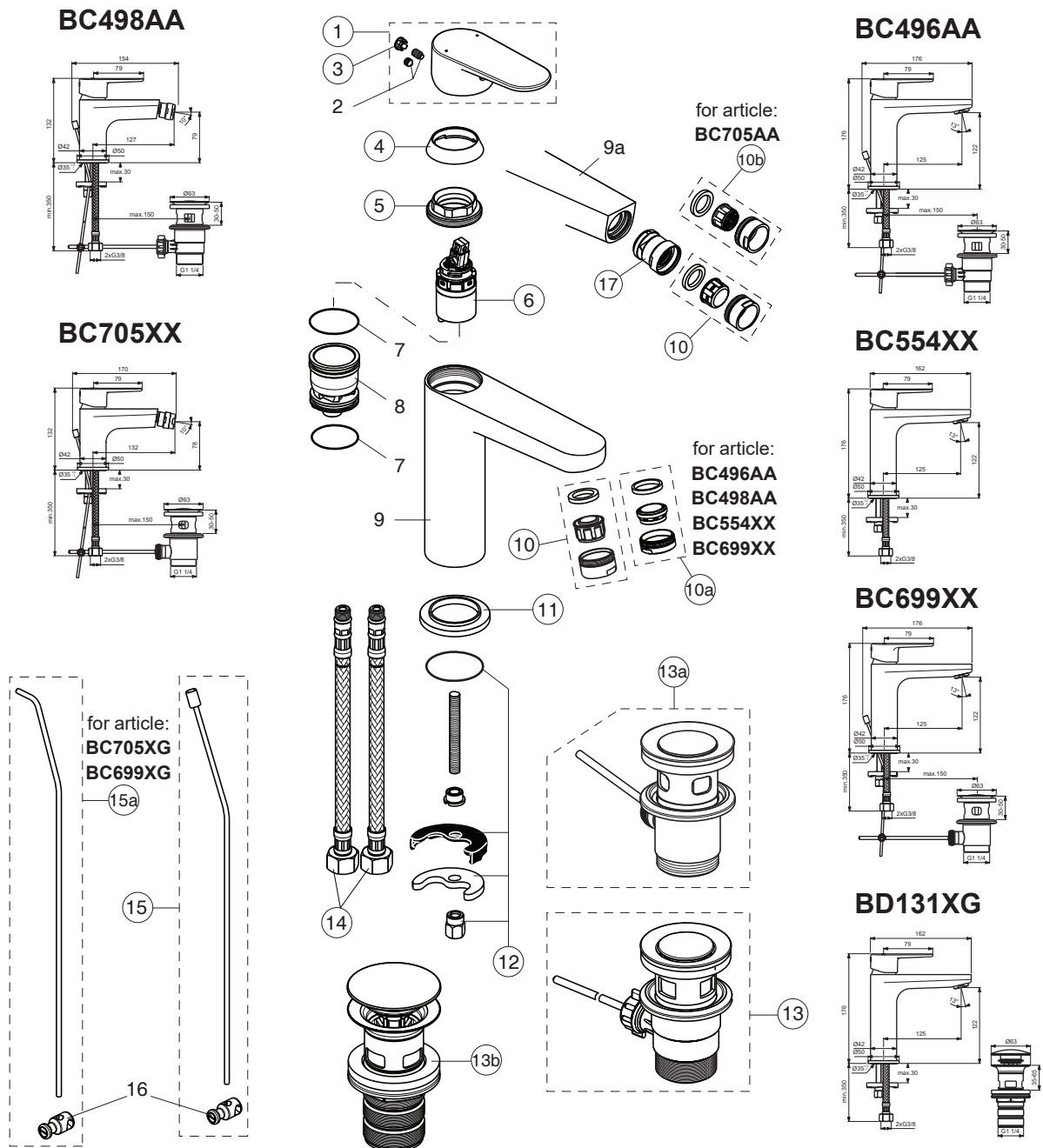

For XX=Coverage-Designate:
AA=chrome, XG=silk black

For Instance:
B961644AA for chrome

Pos.	Signify	Spare parts-Nr.	Quantity	Pos.	Signify	Spare parts-Nr.	Quantity
1	Lever, w/logo-compl.	B961644XX	1 Set	12	Connecting set	B964702NU	1 Pcs.
2	Screw		1 Pcs.	13	Pop-up waste-plastic	B964550AA	1 Set
3	Cap decorative	B964696NU	1 Pcs.	13a	Pop-up drain ass.	A962991XX	1 Set
4	Cap	A861080XX	1 Pcs.	13b	Click waste	E1482XX	1 Set
5	Screw M38x1.5	B961645NU	1 Pcs.	14	Flex hose F3/8 /L445	A962005NU	1 Pcs.
6	Cartridge Ø28mm	A861397NU	1 Pcs.	15	Pop up waste-compl.	B961384AA	1 Set
7	O-Ring Ø30x2		2 Pcs.	15a	Pull-up rod-compl.	B960900A5* (AA)	1 Set
8	Manifold		1 Pcs.	16	Pop up waste shackle		1 Pcs.
9	Body basin		1 Pcs.	17	Ball joint M24x1	A960063XX	1 Pcs.
9a	Body bidet		1 Pcs.				
10	Casc.perlator M24x1-A	A960321XX	1 Pcs.				
10a	Perlator M24x1, 5l/min	B961383XX	1 Pcs.				
10b	Aerator M24x1, 5l/min	B960754AA	1 Pcs.				
11	Rosette decorative	B960712XX	1 Pcs.				

*A5-magnetic grey